

# NANO

# 2

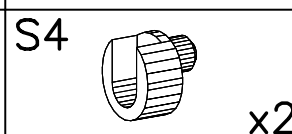

1

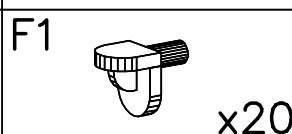
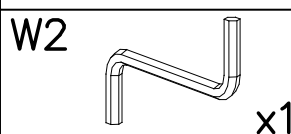
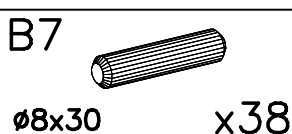
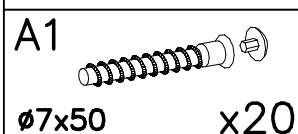
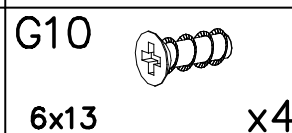
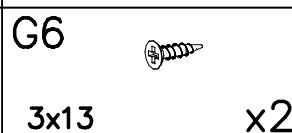
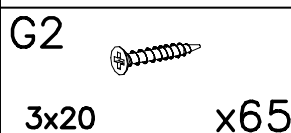
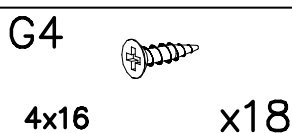
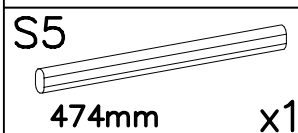
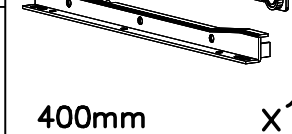
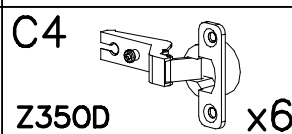
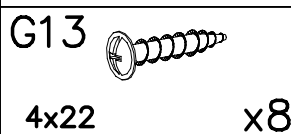
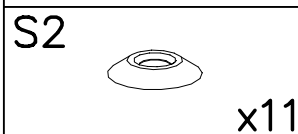
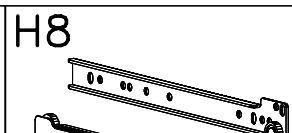
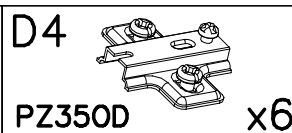
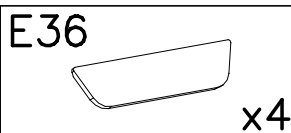
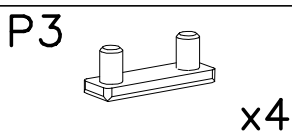
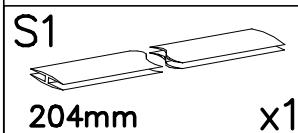
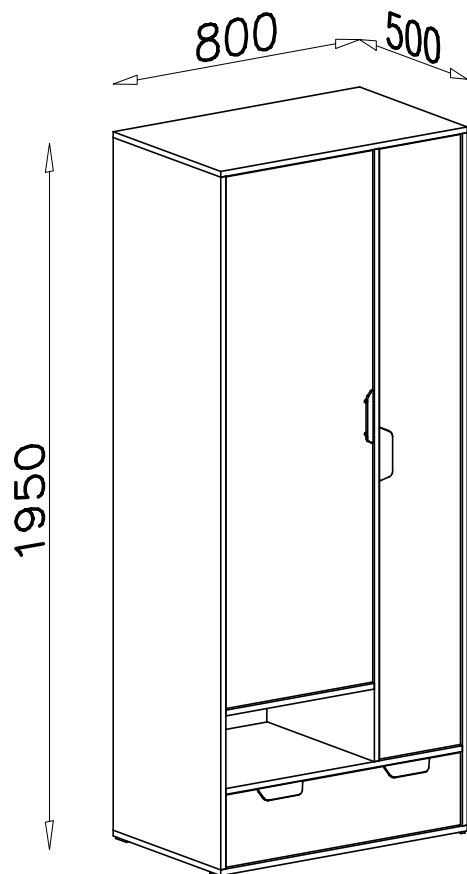
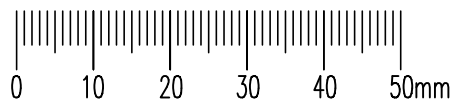
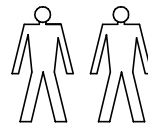
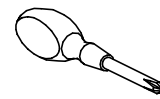
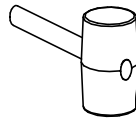
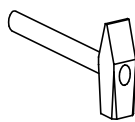
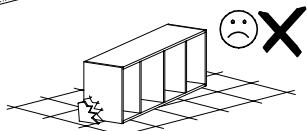
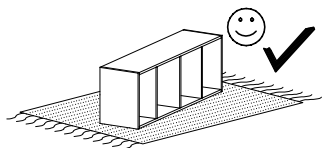
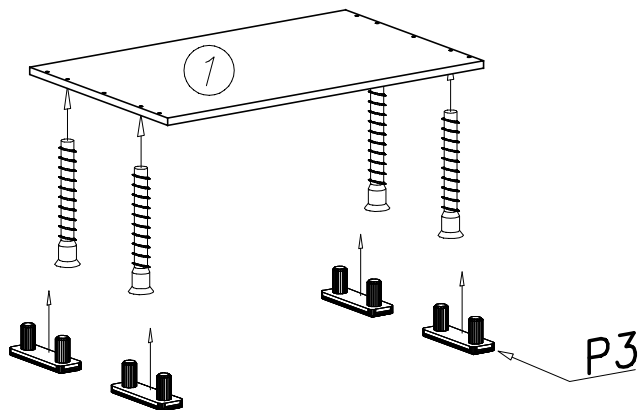
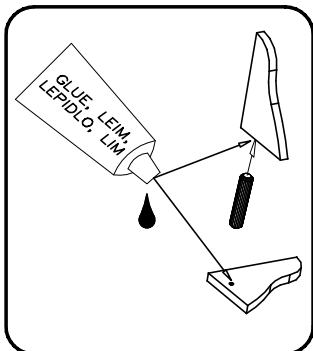
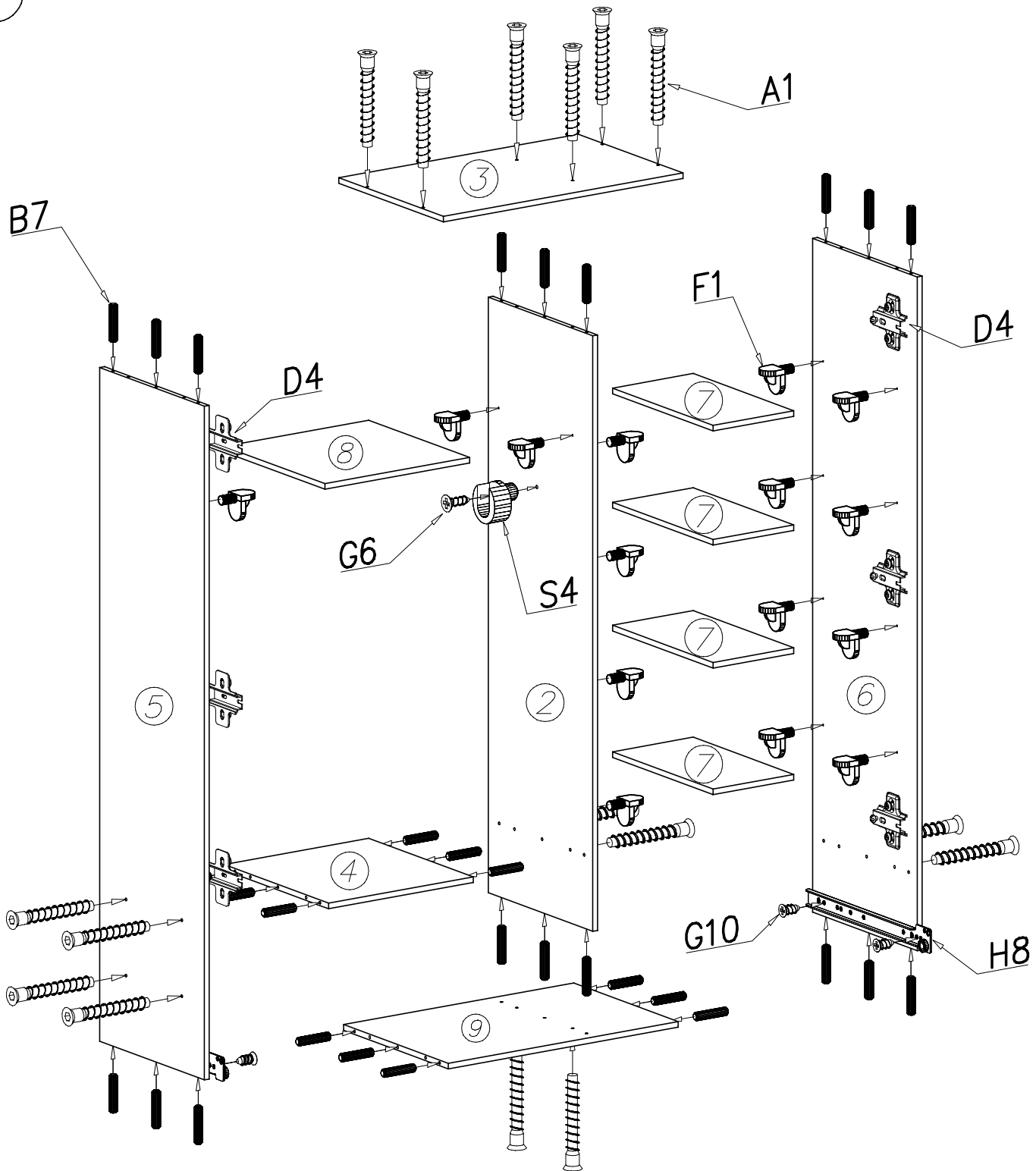

II

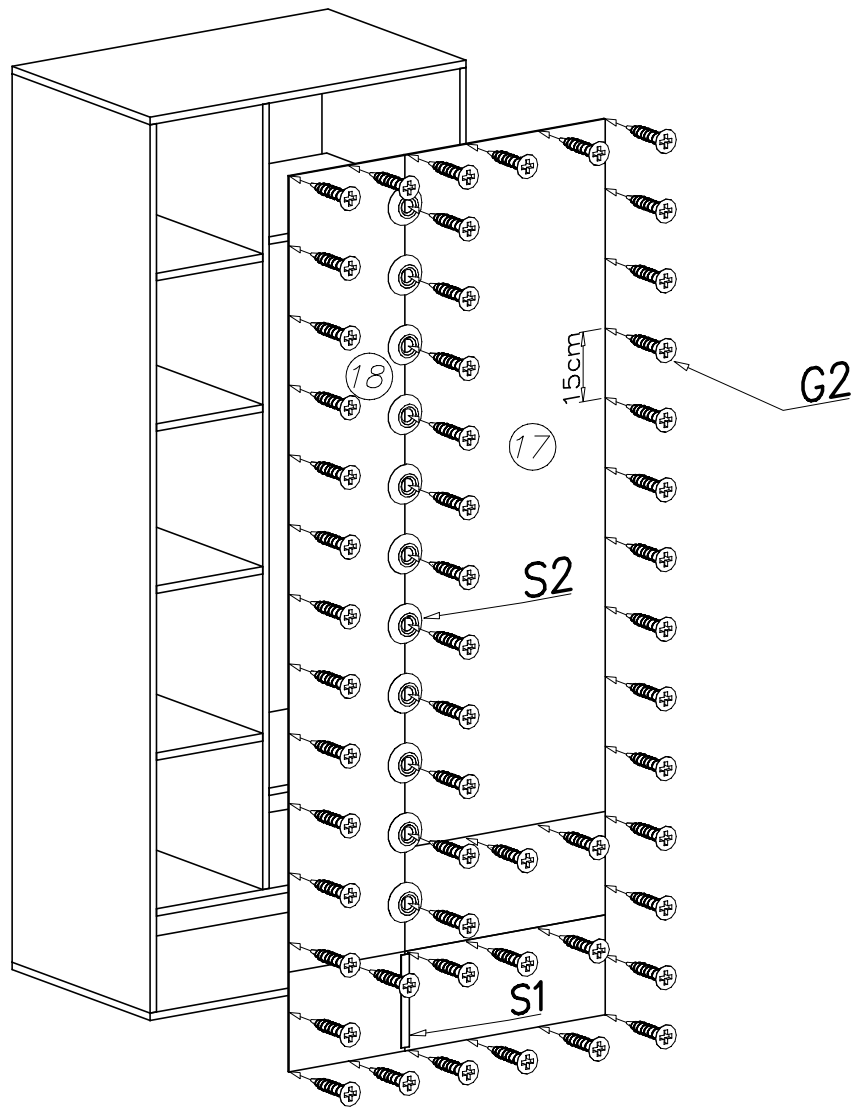

III

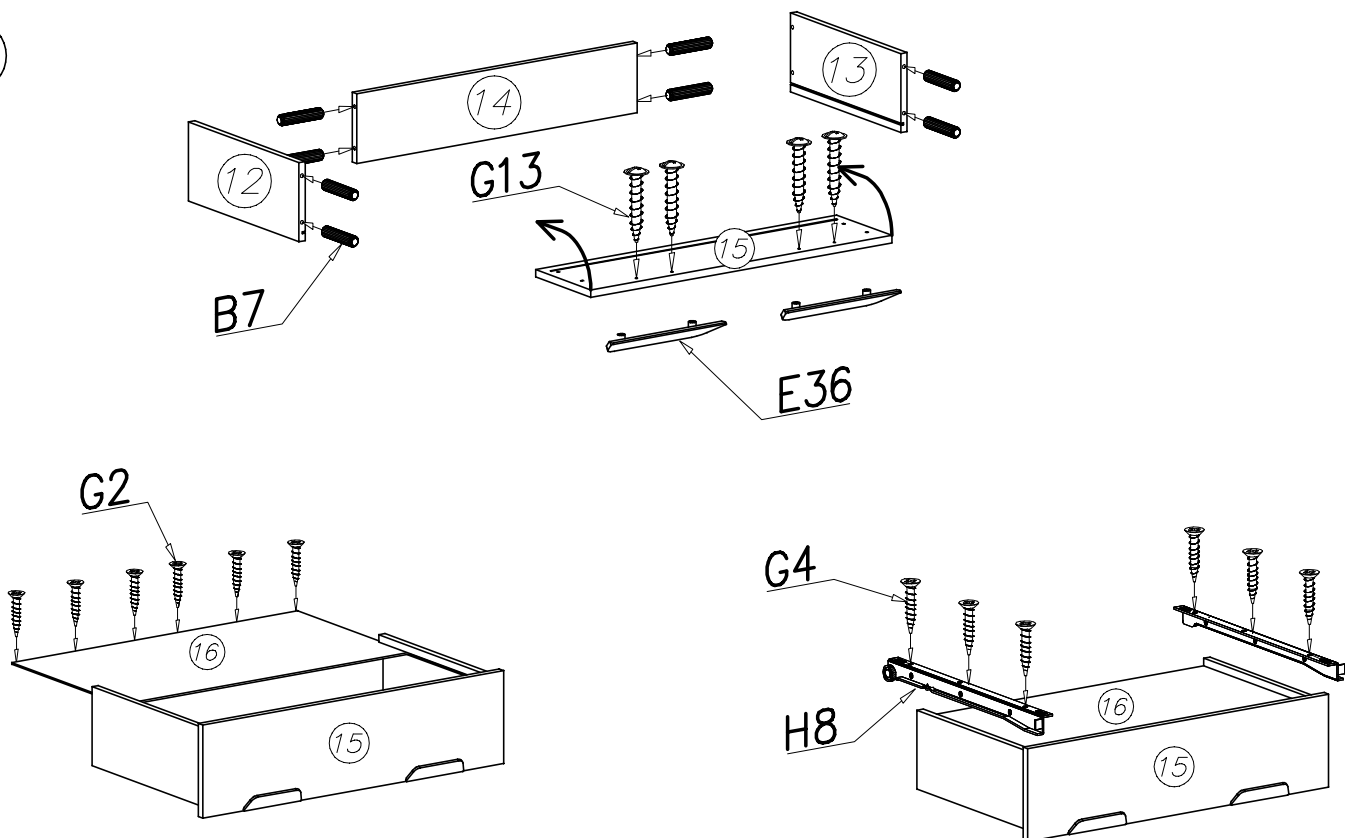

IV

